

1" Heater Shield Installation Instructions

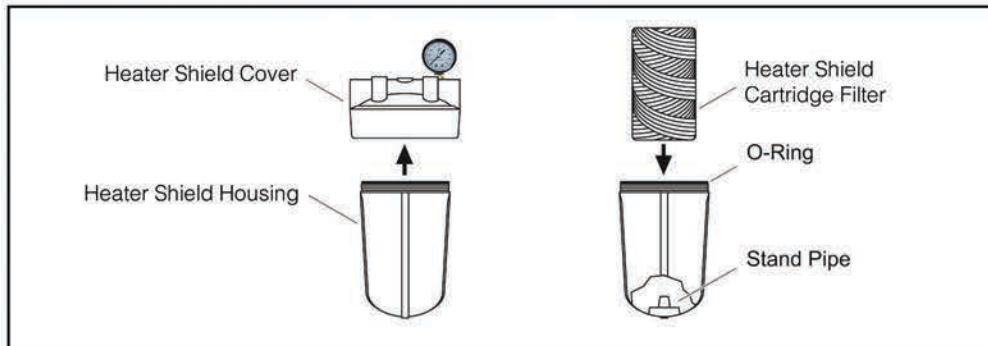

Heater Shield Assembly - 10" Model



1. Unscrew the cover from the Heater Shield Housing.
2. Place the Cartridge Filter onto the Stand Pipe in the Heater Shield Housing
3. Lube the o-rings with clean silicone grease before attaching the cover onto the housing. (Lube is included).
4. Hand Tighten the Heater Shield Housing (counter clockwise).

**Do not use wrench*

Pressure Release Valve

When it comes time to open your Heater Shield Housing, be sure to turn off your water and press the Pressure Release Valve prior to attempting to using the Wrench to open the Housing turning clockwise.

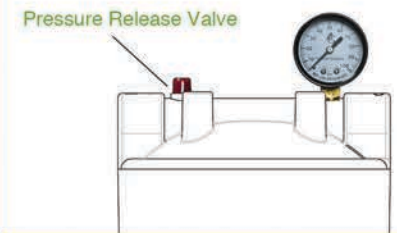

Heater Shield Installation

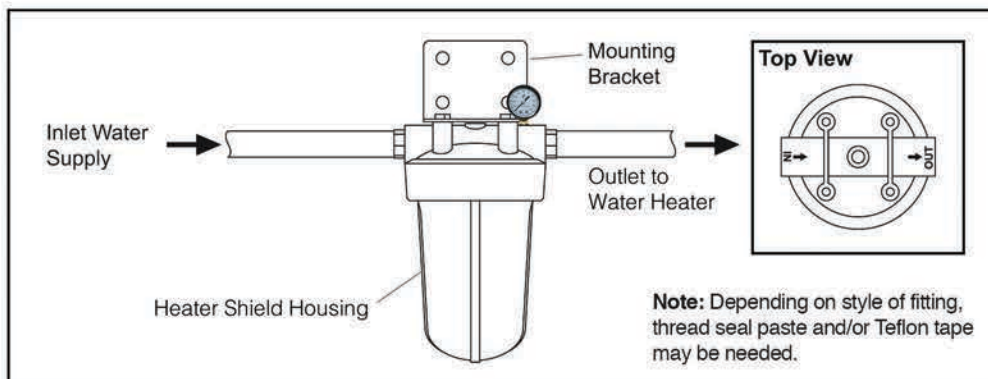

Warning: Do not exceed 80 pSI. If your water pressure is above 80 pSI, you must install a pressure regulator.

Note: To prevent thermal expansion in to the unit, you must install a check valve on the outside of the Water Heater Shield unit.

Note: Install on cold water inlet of water heater. Do not run hot water through the Water Heater Shield. Warranty is void if water temperature exceeds 120°F.

1. Shut off the water.
2. Attach the Mounting Bracket to the wall using the supplied Phillips Head Screws and Washers.
3. Attach the Heater Shield System to the Mounting Bracket using the supplied Bolt Head Screws.
4. Finish by attaching plumbing with 1" male threaded adaptions.
5. **Pressure Gauge Installation**



- A. To Install the Pressure Gauge, put 1-2 wraps of Teflon tape (not provided) on the metal threads.
- B. Use a wrench on the brass base to install. Complete turning of the gauge until it faces forward.

Note: Do not tighten pressure gauge from the black casing.

6. Turn on water and check for leaks.
7. Apply Heater Shield decal to housing.
8. Note initial pressure reading, replace Cartridge Filter when there is a 10 pSI drop or every 6 months.